

STRAPPING HEADS MAXIMUM PERFORMANCE FOR MAXIMUM SAFETY

The heart of every strapping machine is its strapping head. The safety of a load during transport is essentially depending on its performance and specification.

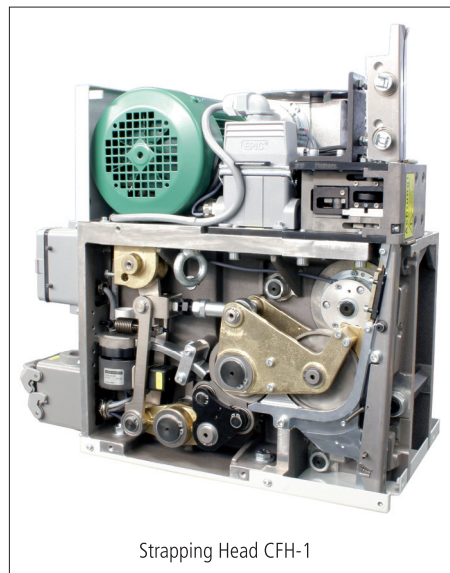

Strapping Head CFH-1

Cyklop – Strapping Head CFH-1

Cyklop has, amongst other things, equipped its strapping heads CFH-1 with the innovative multi-stage-tensioning technology.

The advantage: The strap is not pulled around the product in one go, but in finely-tuned intervals. This innovative technology always guarantees an optimum holding power on the complete radius of the load and optimises the advantage of the modern Cyklop PET straps to the fullest – with up to 5.500 Newton.

- Long stand time due to innovative lubricating system
- Friction weld sealing – no unpleasant odours as there are no vapours
- Compact dimensions
- Service- and maintenance-friendly
- Sealer easily changeable within minutes
- Faster repair processes since some wear parts can be exchanged without dismantling
- Available with two different, innovative Cyklop sealing devices optimally matched to the package

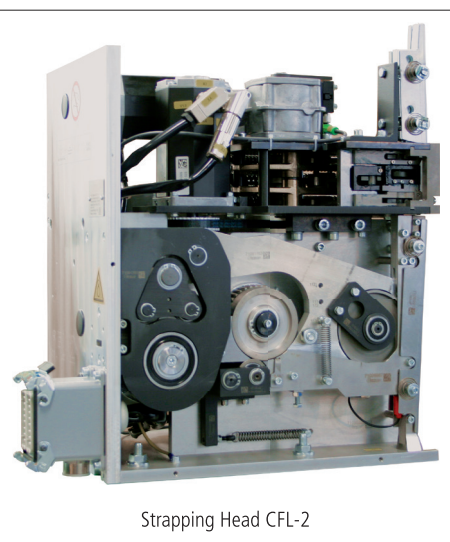

Strapping Head CFL-2

Cyklop – Strapping Head CFL-2

Our newest innovative strapping head has – among other things – a drive concept that is equipped without expanding couplings and with only a single belt, thanks to direct drive.

The result: An unprecedented reproducibility of tension and joint strength, which guarantees and optimum holding power at all times and a very low susceptibility to wear.

- No exchange of tension couplings necessary
- Long stand time due to innovative lubricating system
- Excellent energy efficiency, therefore environmentally-friendly
- Friction weld seal – no unpleasant odours as there are no vapours
- Compact dimensions
- Service- and maintenance-friendly
- Sealer easily changeable within minutes
- Some wear parts can be exchanged without dismantling

Technical Data:

Strap feed / strap retreat:
Strap tension:

Electrical system: Operating voltage:
Total connected load:
Control voltage:
Straps:
- Width:
- Thickness:
Dimensions (L/B/H):
Weight:

CFH-1

2.9 m/s
up to 5,500 N
Infinitely variable
(depending on strap width and thickness)
3/N/PE, 230-415 V, 50- 60 Hz
1.0 kW
24 V DC
PET and PP
9 - 19.0 mm
0.6 - 1.14 mm
approx. 395 x 272 x 445 mm
approx. 79 kg

CFL-2

4.0 m/s
200 up to 2,200 N
Infinitely variable
48 V DC
0.5 kW
24 V DC
PET and PP
9 - 12.0 mm
0.4 - 0.8 mm
approx. 395 x 276 x 455 mm
approx. 59 kg

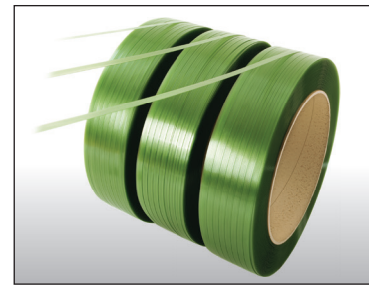

Cyklop PET straps

Rigidity isn't everything - retaining force is crucial

- Higher load safety due to shock reserve and better retaining force
- Higher work safety due to less risk of injury
- Reduction of working costs due to less weight and easy handling
- Reduction of storage and transport costs
- Reduction of complaints thanks to gentle package treatment
- Maximum economy
- Environmentally-friendly due to 100% recyclability

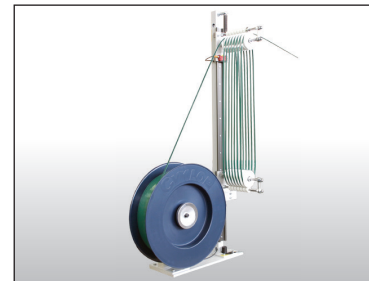

Cyklop plastic strap dispensers

- Weight-independent strap take-up
- Large strap reservoir
- Controlled, kink-free take-up of the retracted strap
- Abrasion-free strap take-up
- Optimally matched to Cyklop strapping head technology



Cyklop wrappers

- Rugged, reliable design with minimal space requirements
- Film stretching steplessly adjustable up to 350 % via display and frequency-controlled motors (optional)
- High-quality rotary arm mounting and drive for long stand time
- Compact design – low transport costs, simple assembly



Training and service to excellent standards

Our experts at Cyklop headquarters in Cologne can often help with advice and instructions per telephone. Cyklop has a supply quota of 96% for spare parts, so that from the start delays don't even occur. All service technicians are trained in Cyklop's own training centre, which is also available for intensive user training. Whether it's a production line requiring regular maintenance or the immediate repair of a malfunction – we are always on the spot for advice, help and service. Cyklop has a very dense customer service network in Germany which guarantees a quick response in case of trouble.

We reserve the right to make technical changes. © Cyklop GmbH, Cologne, observe ISO 16016 protection notice. 05.2015

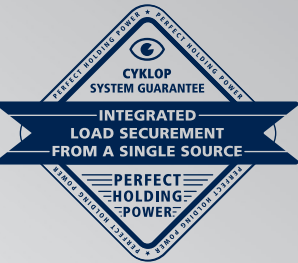
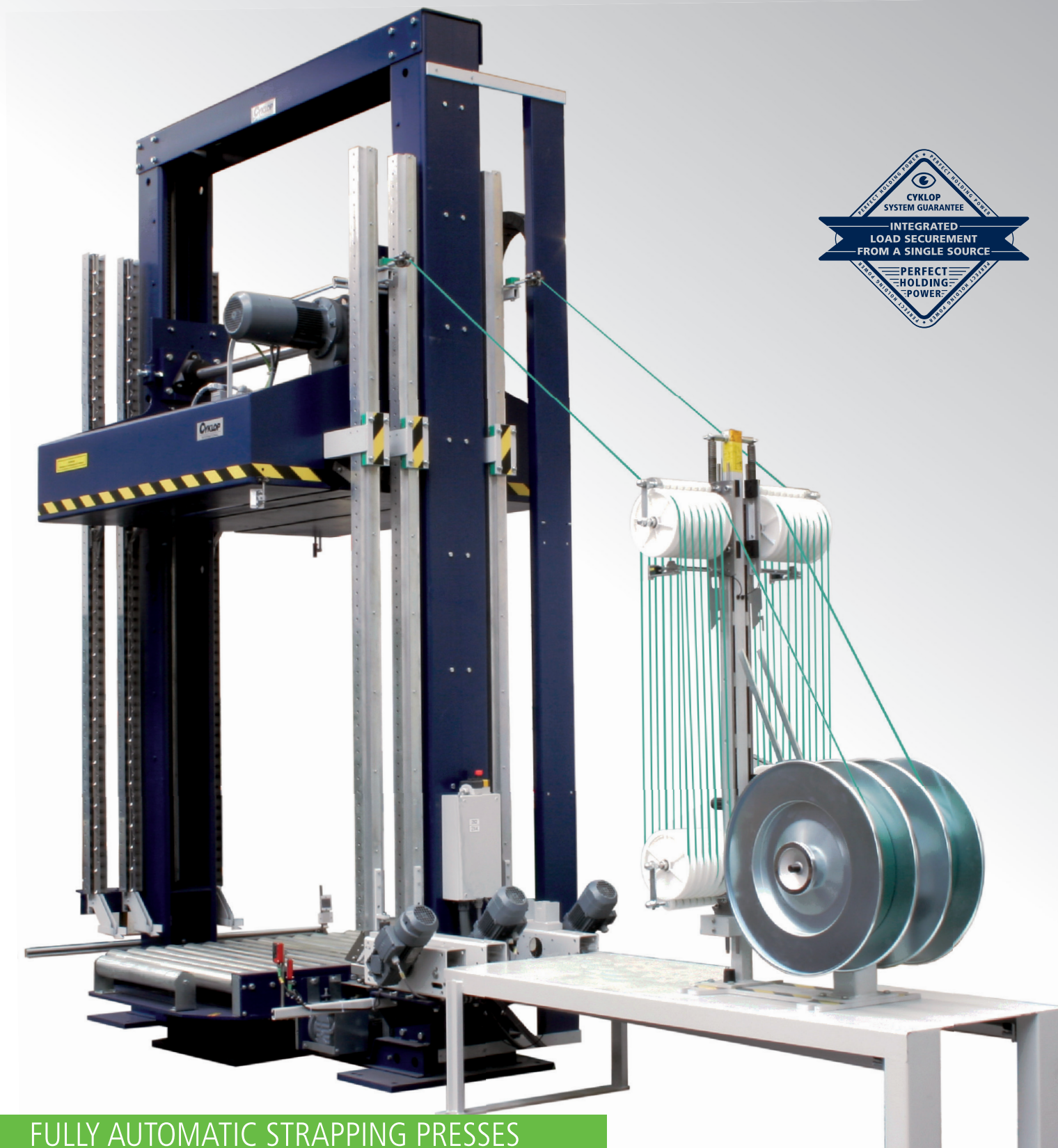

WWW.CYKLOP.COM

DIRECT LINE: +49 (0) 2236 602 0

FULLY AUTOMATIC STRAPPING PRESSES

SERIES XZE

CYKLOP GmbH
Industriestraße 133
50996 Cologne
Germany
info@cyklop.de



STRAPPING PRESSES
FULLY AUTOMATIC FOR MAXIMUM EFFICIENCY



Cyklop – your extra added value

- Optimum strapping results due to high, constant tensioning and retaining force
- Adjustable compaction of the package
- Easy to integrate into existing material handling systems
- Pressing force freely editable in PLC
- Vertical cross strapping possible, e.g. by turntable or lifting/turning cross
- Easy and fast operator control from 5.7" colour touch panel
- No compressed air required
- All machines conform to Machinery Directive 2006/42/EC

Modular structure

The fully automatic, maintenance-friendly Cyklop strapping presses in XZE series feature innovative technology and top quality. Provided with industry-proven and world-leading strapping technology – the Cyklop strapping head CFH-1 with integrated multistage tensioning – the powerful XZE presses ensure fast strapping with maximum tensioning and retaining force. As a world specialist in integrated and customer-oriented system solutions in the field of load securement Cyklop GmbH supplies perfectly coordinated products and services from a single source. As a result, you benefit from maximum reliability and maximum economy.

Main components of the strapping press

- Basic frame, consisting of upper cross beams and two lifting columns with integrated chains or toothed rods, maintenance-free guide elements and standardised connection points for materials handling components
- Compression plate with strapping head mounts, chain sprocket drive or gearwheel drive with servo-controlled asynchronous motor and top-quality, maintenance-free guide shoes
- Stationary strap guides in the vertical area with short flap segments made of stainless steel
- Movable strap guide lances with run time monitoring on pallet contact
- Photoelectric barriers for precision pallet positioning

Optionally integratable standard module for increasing the retaining force:

- **Strap tension equalizer**
The strap tension is distributed evenly round the entire load and thus ensures higher retaining force.

PRESSES IN DETAIL
TECHNICAL DATA

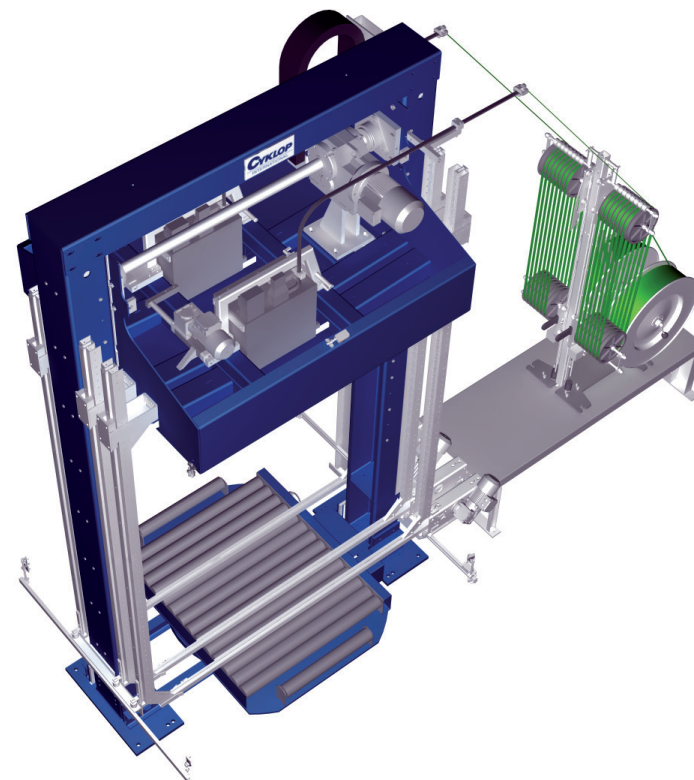

Basic data:

Total machine height:	4,210 mm	Operating voltage:	3/N/PE, (N = load-carrying capacity)
Machine weight:	approx. 4,000 kg (max.)	Control voltage:	24 V, DC
Ambient temperature:	+ 5 °C to + 35 °C	Total power consumption:	approx. 7 kW

Press type	XZE 30	XZE 48
Pressing force	3,000 N	4,800 N
Drive system	Toothed rod	Toothed rod
Press time (adjustable)	max. 4 s	max. 4 s
Pallet weight *	up to 1,500 kg	up to 1,500 kg
Strap guide system	3 strap guides	3 strap guides
	2 strapping heads	2 strapping heads
	2 strap guides 1 strapping head	2 strap guides 2 strapping heads
Passage width	2,200 mm / 2,700 mm or 3,400 mm	2,200 mm / 2,700 mm or 3,400 mm
Passage height	max. 2,700 mm	max. 2,700 mm
Height of roller conveyor	from 300 mm	from 300 mm
Conveyor systems	Roller conveyor / Roller conveyor with turntable / Roller conveyor with turntable and lateral movement/Roller conveyor with centraliser / Roller conveyor with lifting/turning cross / Roller conveyor with centraliser and lifting/turning cross	

* depending on conveyor systems strength

PRESSES IN DETAIL
INDUSTRY SOLUTIONS FOR MAXIMUM PRODUCTIVITY

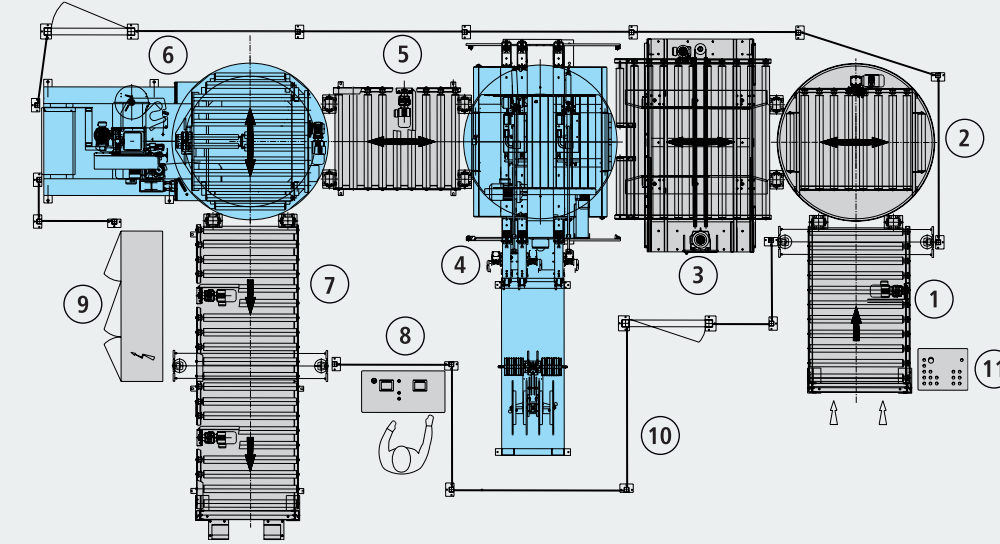

Example of flow

- | | | | |
|------------------------|----------------------------|------------------------|---------------------|
| 1 = Conveyor equipment | 4 = Strapping press XZE | 7 = Conveyor equipment | 10 = Guarding fence |
| 2 = Turning station | 5 = Conveyor equipment | 8 = Control desk | 11 = Control desk |
| 3 = Centraliser | 6 = Pallet wrapper GL 1020 | 9 = Control cabinet | |

Press type	XZE 30	XZE 48
Applications	Paper Printed products	Corrugated cardboard Printed products Glass

The Cyklop strapping systems – practice-proven to guarantee maximum retaining force

As a leading supplier and expert in the field of load securement Cyklop GmbH offers you system solutions specially tailored to the specific requirements of your company. After all, as an industry specialist we know what counts. Our innovative and precisely coordinated machines and materials are continuously being enhanced by our technical experts and they are used throughout the world in all the key sectors of industry. Our XZE series strapping presses, featuring state-of-the-art PET technology, are used in a very wide range of industries, such as the corrugated cardboard, paper, printing and bottle glass industries.

Owing to their modular design the high-performance, low-maintenance XZE series meets both small and large capacity requirements. With strapping presses from the house of Cyklop you boost your productivity, cut your costs and increase the safety of your cargo.